

## DEVELOPMENT OF STRATEGIES FOR REDUCING TRACTION ENERGY CONSUMPTION BY ELECTRIC ROLLING STOCK

Serhiy Yatsko, Yaroslav Vashchenko, Anatoliy Sydorenko

Ukrainian State University of Railway Transport, Kharkiv, Ukraine  
*ua.yatsko@gmail.com, yaroslav.vashchenko@gmail.com, sidorenko58@gmail.com*

**Abstract:** The paper considers a method of increasing the energy efficiency of the traction power consumption during operation of a non-autonomous electric rolling stock equipped with an onboard energy storage. The idea is to use the onboard energy storage of the electric braking as an additional power source for the traction electric drive in the process of vehicle acceleration and to coordinate its work with the power supply system. This not only ensures the independence of the processes of electric power consumption and kinetic energy recovery by the traction equipment, but also reduces losses in the elements of traction and external power supply systems. To confirm the effectiveness of the proposed method, we simulated the operation of a metro train with asynchronous traction electric drive in combination with the proposed system. The results obtained, in this case, demonstrated a reduction of energy losses in the elements of the traction power supply system during the electric train acceleration by 45 % compared with the losses when using a regular traction drive system. Attention is paid to the factors and their characteristics that exert significant influence on the traction and electric braking processes.

**Key words:** energy efficiency, power consumption, electric rolling stock.

### 1. Introduction

Most electrified transport is characterized by sharply changing, repetitive, short-term modes of the traction electric power consumption, with phases of recuperative braking realization. High intensity and frequency of their behaviour accompanies the occurrence of significant energy losses in the traction power system elements. According to the latest calculations, the amount of energy spent on the traction can reach 12 % [1].

Today, onboard energy storage systems are one of the principal means of energy saving technologies and energy efficient transportation systems. The result of their application consists in the local buffering of electric braking energy that accompanies the reduction of the energy losses in the elements of the electric traction system, and almost completely solves the problem of adsorption of surplus recuperation energy. However, the problem of optimal use of the accumulated energy remains unsolved, which will require additional research.

### 2. Problem Statement

The analysis and generalization of the published scientific works demonstrate the existence of the developed system solutions and algorithms for controlling the process of energy absorption by the drive,

which made it possible to overcome the obstacles of application of electric braking [2, 3]. However, despite the accumulated theoretical and practical experience, there is a lack of complex solutions based on energy storage systems aimed at minimizing technical and economic losses caused by the irregularity of traction load [4]. Thus, in the context of the need to save energy resources, the urgency of this problem is high on the list of the methods being applied in the electric transport industry to increase energy consumption efficiency.

### 3. Principal Part

Regenerative braking makes it possible to reuse much of the kinetic energy of the rolling stock. Our experimental research into the energy consumption by the traction rolling stock of an underground railway demonstrates that energy savings from the use of electric braking can reach up to 40 % of the total traction electric energy consumption (Fig. 1).

Today, the search for an effective solution for the use of electric braking in transport is carried out not only regarding its barrier-free use, but also from the perspective of the possibility to reduce losses in the traction power supply system due to its application. One of the key tools for increasing the energy efficiency of electric transport, as an element of the complex, is the application of energy storage. Currently, there are two main ways of using energy storage devices, namely in the electric power supply system (stationary), and on board of the rolling stock.

The use of storage devices in the power supply system has a number of advantages, namely maintaining the average voltage in the network, and in some cases – reducing, to a certain extent, the energy losses related to its transmission during regenerative braking, and carrying it out regardless of the presence of active energy consumers in the network. However, there is a number of disadvantages, the principal ones being: energy losses both in the process of the surplus energy absorption and during its recovery, the necessity of transport infrastructure expansion associated with the search for the optimal placing of the storage device (frequency of recuperative braking, potential volume of regenerative braking surplus energy, possibility of receiving the maximum possible surplus energy). Today, on-board energy storage is considered to be an alternative to stationary storage.

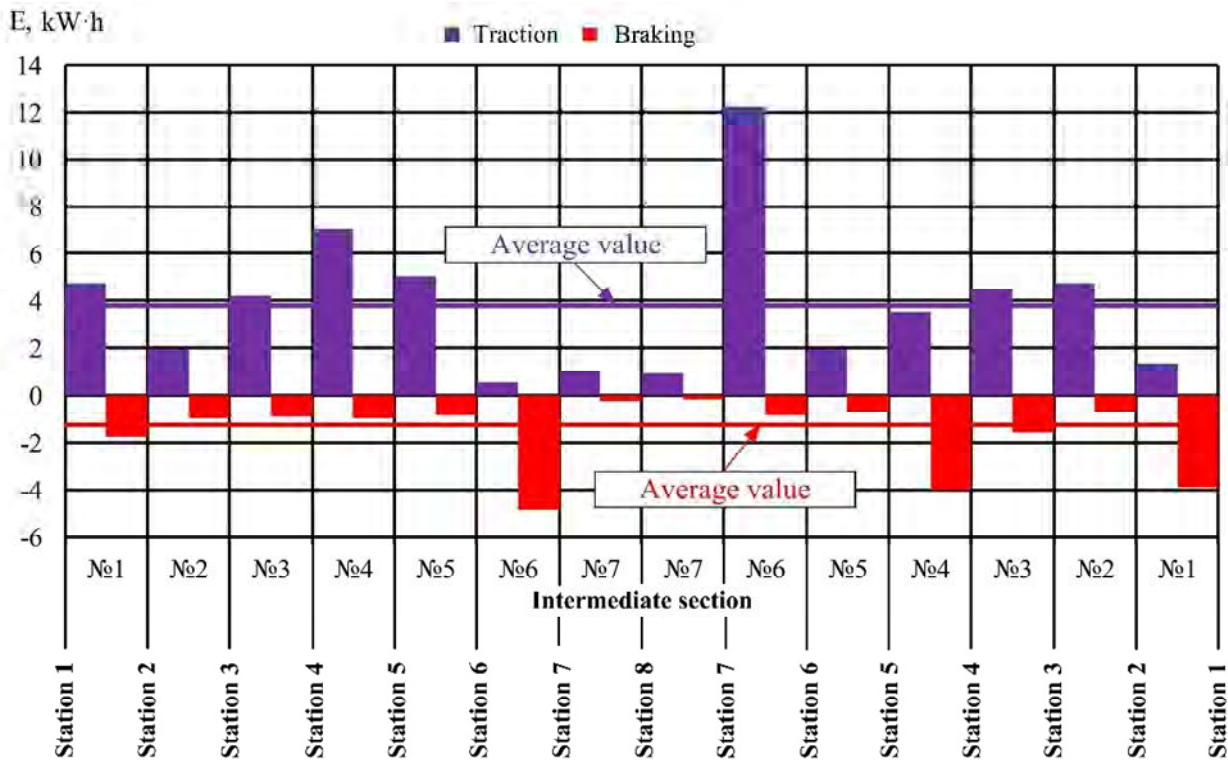

Fig. 1. Energy pattern of an asynchronous traction electric drive underground railway train operation.

At this stage of the development of energy storage, a number of key directions of the reuse of stored energy on board of a vehicle can be considered. First, it is the stabilization of the supply voltage of the traction equipment of the rolling stock during its operation, second, it is the use of the energy as a power source for additional electric equipment, safety, comfort and train communication facilities, and the use as an energy buffer for further transfer of the energy to other storage devices as, for example, an electric power storage battery [5, 6].

In general, losses in the traction energy system can be divided into three components. These are losses in the elements of traction substation  $\Delta A_{TS}$ , in the elements of traction network  $\Delta A_{TN}$  and elements of electric equipment of traction rolling stock  $\Delta A_{ED}$  [7, 8]. Table 1 shows a comparative appraisal of the component losses in the traction power system that exist when using stationary and on-board energy storage devices in different modes of the vehicle operation (Fig. 2).

Having analysed the results obtained in the process of the comparative appraisal of the component losses (Table 1), and their modification depending on the energy storage used, we have determined an alternative approach to the use of stored energy. The approach consists in the use of energy of the onboard  $E_{ES}$  drive as an additional power source for the traction electric drive

at the time of traction mode implementation. It is proposed to achieve this by constructing an additional circuit to regulate traction network consumption current  $I_{TN}$  (Fig. 3). The use of an onboard storage unit in this way not only eliminates the necessity of power transit at the intervals of regenerative braking (absence of  $\Delta A_{TN}$  during braking) but also optimizes the flow of current  $I_{TN}$  in the mode of traction that results in reducing the irregularity of electric power consumption, minimizing the additional losses of  $\Delta A_{TN}$ .

Table 1

**Comparative Appraisal of Component Losses in the Traction Power System that Exist when Using Stationary and On board Energy Storage Devices**

Total energy consumption reduction method	Mode of operation	$\Delta A_{TS}$	$\Delta A_{TN}$	$\Delta A_{ED}$
Stationary energy storage	Traction	±	+	+
	Braking	-	+	+
Onboard energy storage	Traction	±	±	+
	Braking	-	-	+
+ loss reduction - no loss reduction ± reduction of losses				

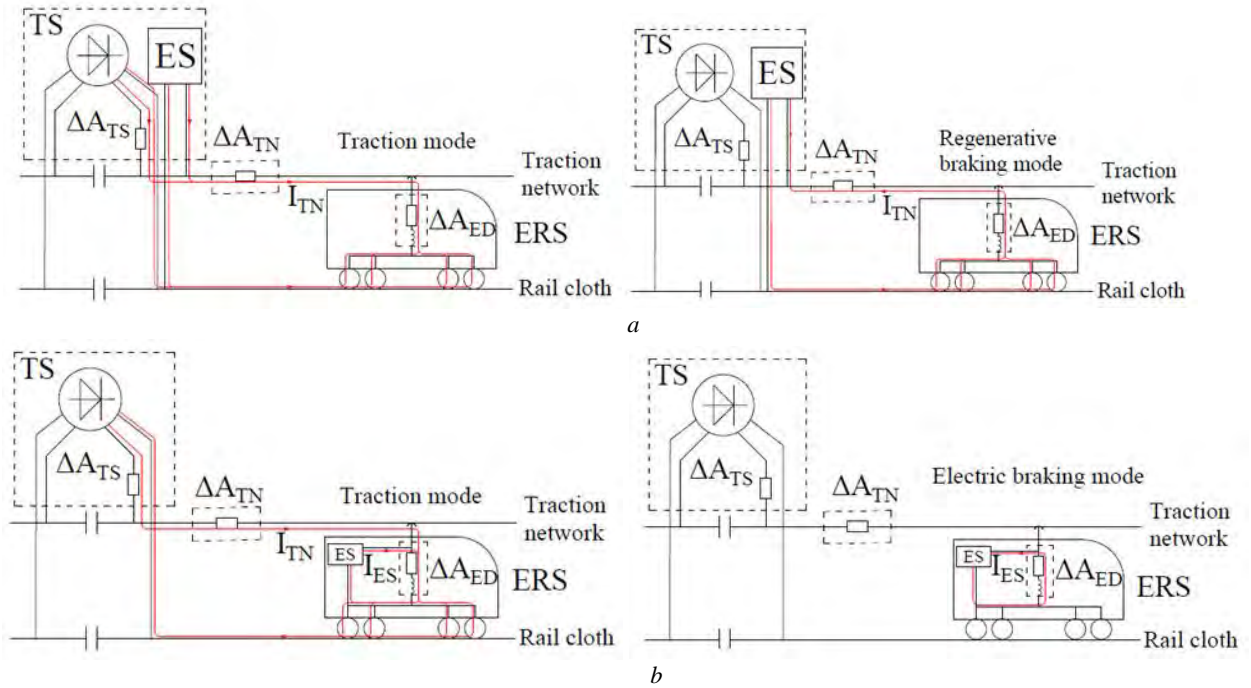

Fig. 2. Simplified functional flowchart of energy exchange processes in traction power system: a) with stationary energy storage; b) with onboard energy storage: TS – traction substation; ES – energy storage; ERS – electric rolling stock;  $I_{ES}$  – onboard energy accumulator current;  $I_{TN}$  – traction network current.

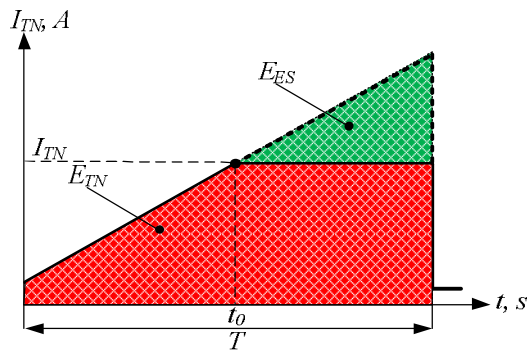

Fig. 3. Optimization of power transit through the contact network due to the onboard energy storage

The peculiarity of implementing this method of increasing energy efficiency is the need to determine the start time  $t_0$  of optimization of energy consumption from the traction network based only upon the data of accumulated energy and the predicted value of energy consumption by traction rolling-stock equipment for the acceleration of the vehicle for a particular section of road (Fig. 3). The initial stage of calculating  $t_0$  is to determine the time interval of the acceleration process  $T$ . The calculation is based on the formula that represents the energy consumption of the traction drive to ensure the movement of the vehicle:

$$E_F = U \cdot \int_0^T i(t) dt, \quad (1)$$

where  $U$  denotes the power supply voltage of the traction rolling stock;  $T$  stands for the predicted time interval of the transportation vehicle acceleration;  $i(t)$  is the law of changing the traction rolling stock current consumption.

According to formula (1), it seems possible to determine the predicted time interval of the vehicle acceleration process by  $i(t)=(a+b \cdot t)$ :

$$T = \frac{-a + \sqrt{a^2 + 2 \cdot b \cdot E_F}}{b} \quad (2)$$

Time  $t_0$  is determined on the basis of the energy balance equation, taking into account the energy from an additional power supply source (Fig. 4):

$$E_F = E_{TN} + E_{ES0} \rightarrow t_0 = T - \sqrt{T^2 - \frac{2 \cdot (E_F - a \cdot U \cdot T - E_{ES0})}{b \cdot U}}, \quad (3)$$

where  $E_{TN}$  is the energy consumed by the traction electric drive from the traction network to assure the vehicle operation;  $E_{ES0}$  stands for the initial value of power of an additional power supply at the beginning of optimization of power transit through the traction network.

To confirm the correctness of the mathematical model, in Matlab/Simulink software environment, we carried out a simulation of an underground railway train operation, the train being equipped with an asynchronous traction electric

drive in combination with traction network energy consumption optimization system, where an additional supply power source is applied (Fig. 4). An additional power supply source is a capacitive energy storage.

The simulation was carried out with the following values of the mathematical model parameters: the energy accumulated in an additional power supply source is 20.5 MJ ( $E_{ES0}$ ) at the beginning of the optimization of the power transit, the predicted value of the energy consumption of the traction rolling stock for the acceleration of the vehicle is 69.05625 MJ, the law of

consumption current modification of traction rolling stock is represented by  $850+160 \cdot t$ , the traction network voltage equals 750 V. The law of changing the current consumption was obtained as a result of approximation of the oscillograms of the input current of the traction electric drive of a real sample of an underground carriage. The predicted value of traction rolling stock energy consumption for the vehicle acceleration was defined as energy consumption by a train on one of the underground lines. Fig. 5 shows the oscillograms obtained as a result of the simulation.

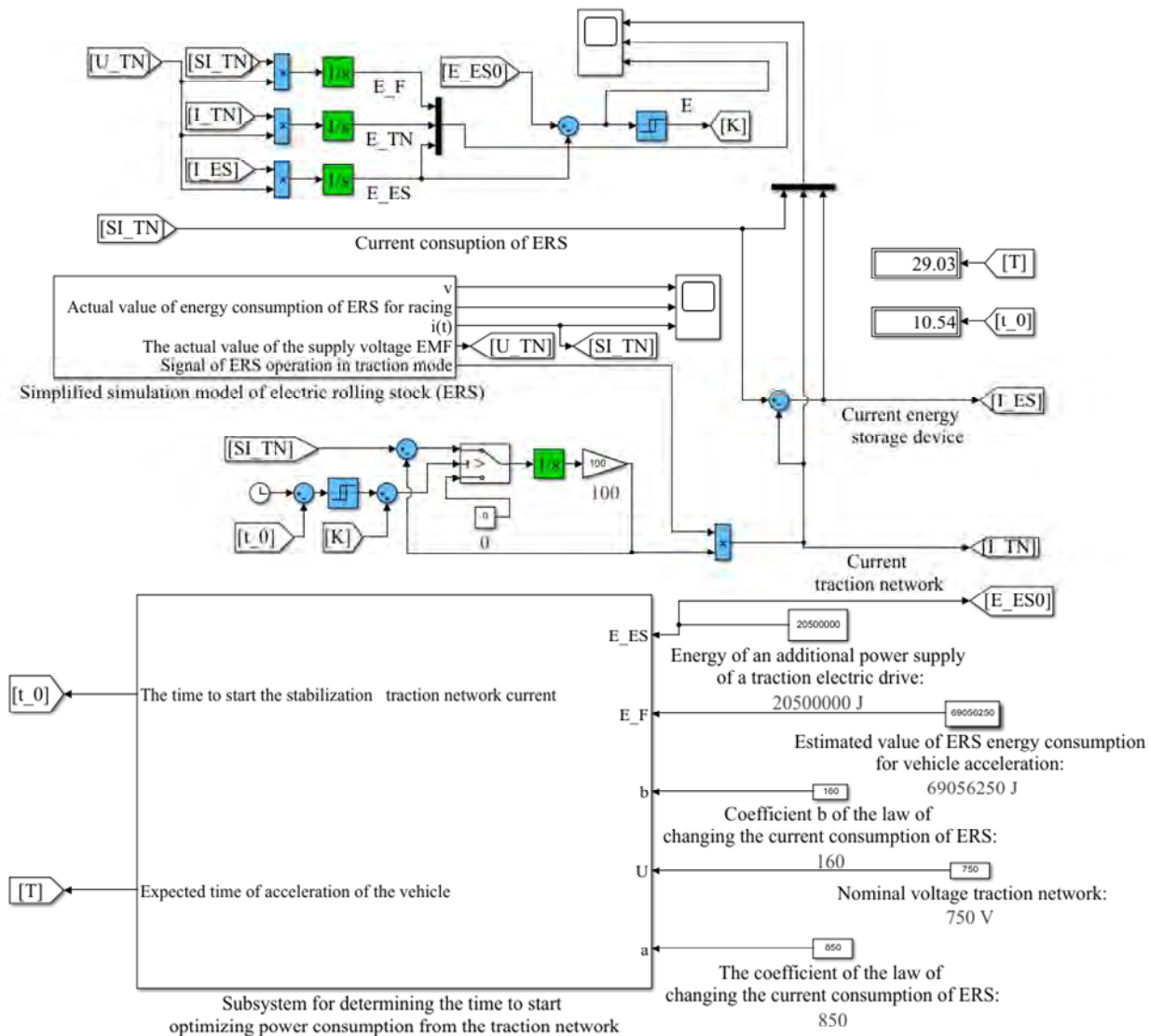

Fig. 4. Simulation model of traction rolling stock operation, combined with the system of traction network energy consumption optimization.

The simulation was carried out for 50 sec., with the traction mode being implemented for 29 sec., and the optimization process started from 10.5 sec. Fig. 5 shows the simulation results that reflect the process of optimization of energy consumption from the traction

network in the process of underground train acceleration. Curve 1 (Fig. 5) represents an oscillogram of the consumption current by a traction electric drive. Its initial value of 850 A represents the process of traction motors magnetization. Curve 2 demonstrates the current

flow through the contact network. The absence of the abnormal current jumps confirms the correct calculation of the start time of optimization of power consumption from the traction network. Correctness of the developed model can be confirmed by the fact that the algebraic

sum of energies  $E_{TN}$  and  $E_{ES0}$  corresponds to the predicted value of the energy costs  $E_F$  (curves 4-6), at that the energy accumulated in the onboard energy storage device to participate in energy exchange, is used in full (curve 7).

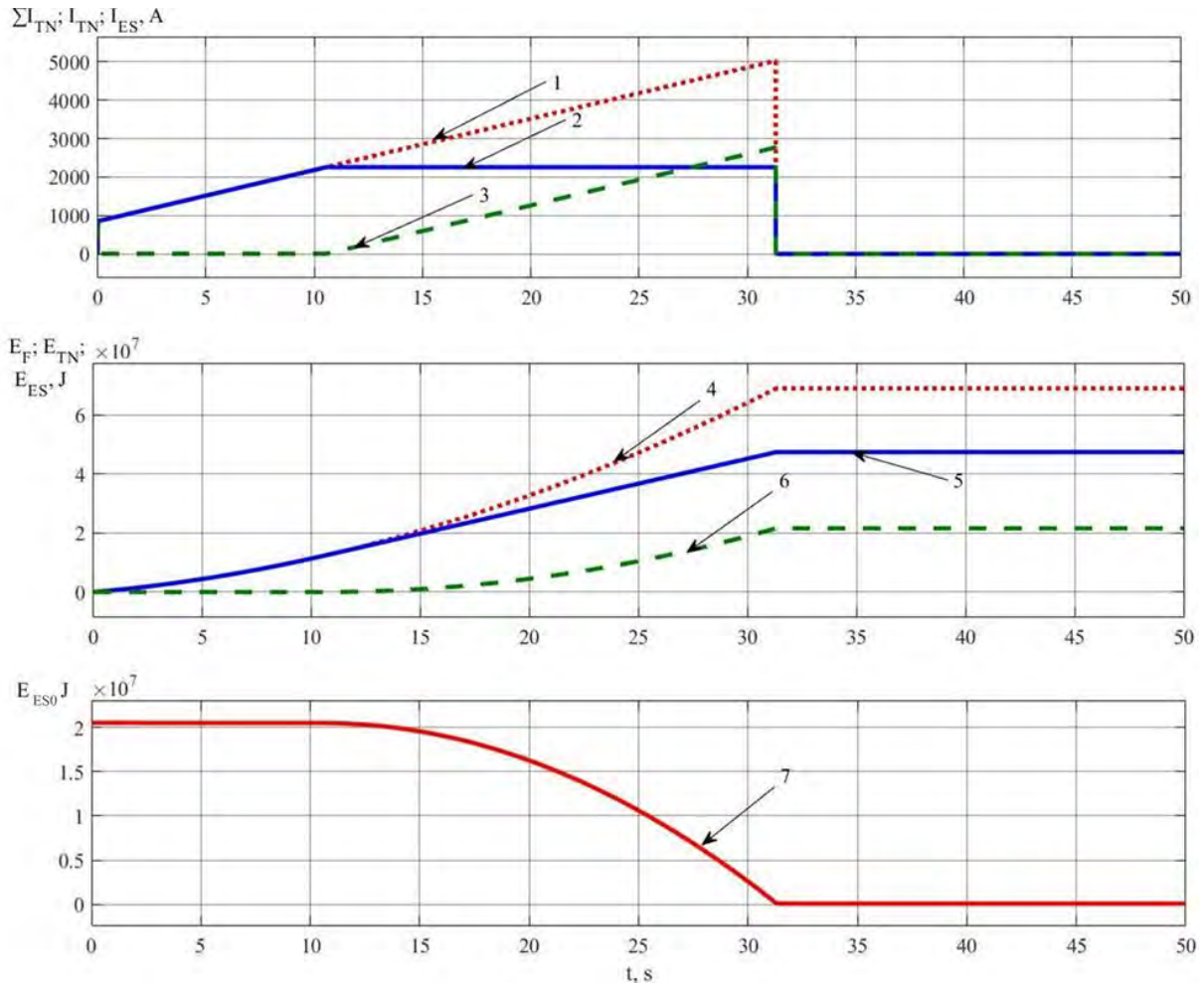

Fig. 5. Oscillograms of optimization process of power transit through contact network by means of onboard energy storage unit:

1 – traction rolling stock current consumption  $\sum I_{TN}$ ; 2 – traction network current  $I_{TN}$ ; 3 – current of onboard energy storage as an additional power supply source of traction electric drive  $I_{ES}$ ; 4 – energy consumed by traction electric drive to assure the vehicle operation  $E_F$ ; 5 – part of the energy consumed by traction electric drive from traction network, to assure the vehicle operation  $E_{TN}$ ; 6 – energy consumed by traction electric drive from the additional power supply source of the traction electric drive during optimization of power transit from traction network  $E_{ES}$ ; 7 – residual energy in onboard storage  $E_{ES0}$ , which is involved in power exchange.

To assess the correctness of the decisions taken to improve the energy efficiency of electric transport, we use the average integral factor of minimum, or “Pick Factor”, which is the ratio of the maximum momentary power achieved within one traction mode to the average value of the power realized by maintaining the specified mode. The Pick Factor calculation was carried out for a 300-second track section with the energy consumed by traction rolling stock equal to 69.05625 MJ, and the energy accumulated in the additional supply power source – 20.5 MJ. At that, the following assumptions

have been made: traction and braking modes are realized only once over the whole track section, after the vehicle has achieved the determined speed, there occurs a transition from a traction mode to a stopping mode. The Pick Factor was calculated using the following formula:

$$P = \frac{P_{\max}}{P_{\text{average}}} = \frac{P_{\max}}{\frac{1}{T} \cdot \int_0^T p(t) dt} \quad (4)$$

The results of the Pick Factor calculation confirm the effectiveness of the method for stabilization of the

consumption current from the traction network. Thus, in the case of energy consumption from the traction network without the use of an additional power source, the Pick Factor is 16.4. And when the optimization of power transit is provided by an additional power source during the vehicle acceleration under the same operation condition, it achieves 7.4. This allows us to claim not only the reduction of the total energy consumption for traction, but also the increase in the energy consumption efficiency of the electric power supply system. Besides, based on the simulation results it was founded that under these conditions, the proposed method of energy consumption efficiency increase has reduced the energy losses in the elements of traction electric supply system during the train acceleration by 45 %, compared to losses when using a regular system of traction electric drive.

It should be noted that the course of traction and electric braking depends on a large number of factors: a plan and profile of tracks, an operation time interval, congestion of one or another route traffic, conditions of tracks and traction network facilities, voltage on the rolling stock current collector (Fig. 6), rolling stock technical conditions, etc. All these factors affect both the energy value of the vehicle and the amount of recovered energy. In most cases, all of the above factors are a function of many random variables whose characteristics and influence degree are at different levels. The subjective factor is one of the significant factors for determining the energy consumption and energy recovery levels. That is, the total energy costs for traction depend on the state of the driver, his individual

characteristics, the level of training (Fig. 7). Thus, it produces sufficiently wide distribution of traction rolling stock energy consumption and energy recovery frequency values, which in every specific case is subject to different laws of random variables distribution (Fig. 8), complicating significantly the prediction of energy consumption and recovery by means of the traction rolling stock units, even in the determined track sections.

Thus, the proposed method for increasing energy efficiency, combined with those to minimize the influence of at least subjective factors on the operation of track vehicles, will assure, to some extent, the predicted energy exchange, and minimize losses in the elements of traction electric supply system without considerable expansion of the infrastructure.

#### 4. Conclusions

1. Based on the results of the research, it was found that the use of an onboard energy storage as an additional power source for traction electric equipment allows us to solve a number of problems not only related to utilization of surplus regenerative energy, but also to reduction of energy consumption irregularities in the traction power supply system;

2. Based on the analysis of energy diagrams and oscillograms of energy exchange processes during the operation of electric transport, it has been stated that the intensity of its energy consumption and energy recovery depend on a complex of factors that are both random and subjective.

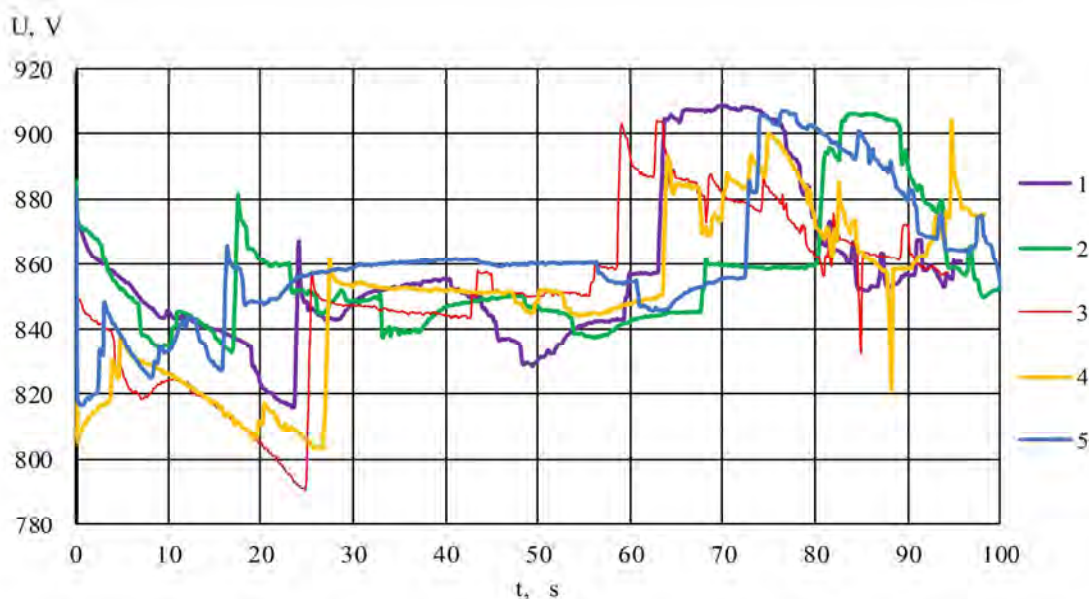

Fig. 6. Oscillograms of voltages on the contact rail of an underground railway at different time intervals.

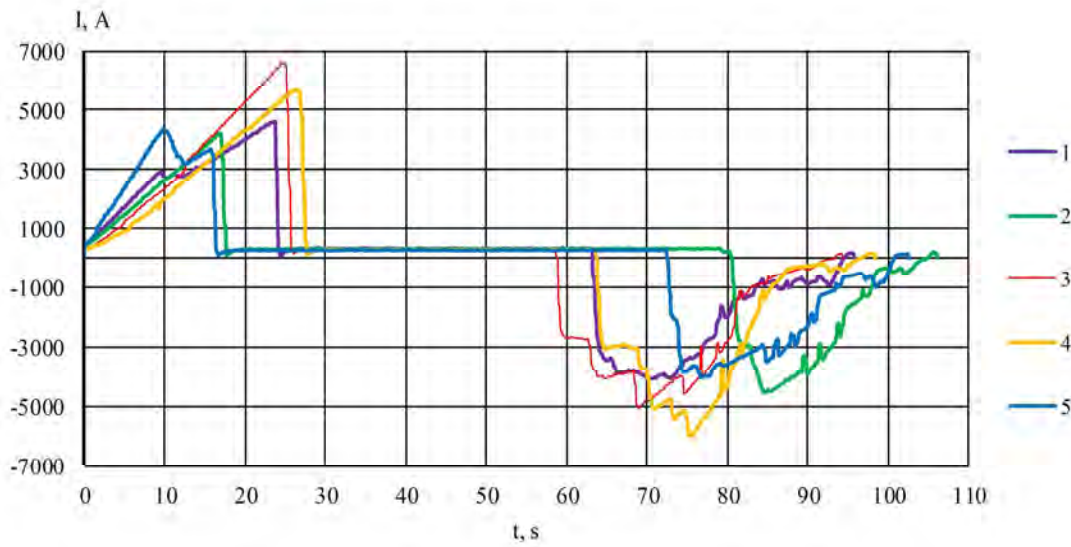

Fig. 7. Oscillograms of current, when an underground train is driven by different train drivers on a specific track section.

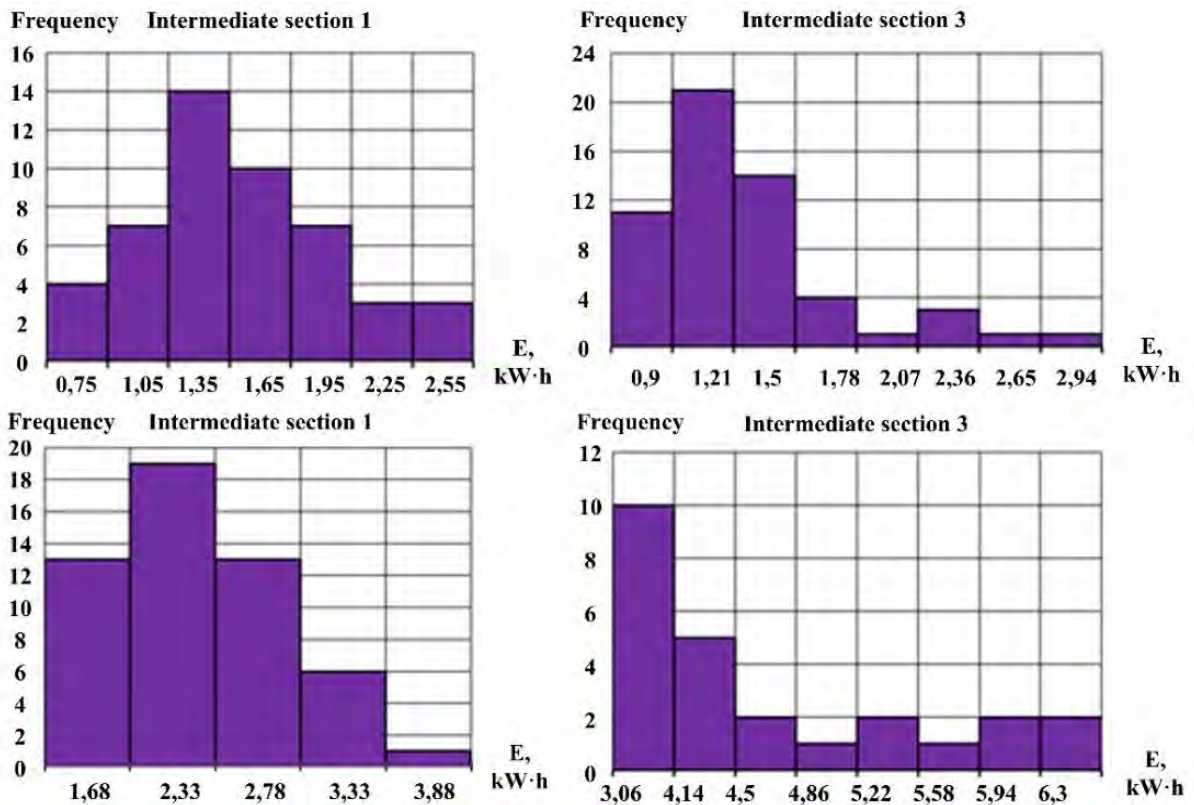

Fig. 8. Histograms of frequency distribution of energy recovery values by traction rolling stock of underground train on different interstation sections.

3. The further development of the proposed system is seen in the improvement of the methods for determining the time of beginning of optimization

of the power transit over the traction network, based on the application of expert and intellectual algorithms.

## References

- [1] M. V. Shevlyugin, *Resource and energy-saving technologies in railway transport and subways, implemented using energy storage*, Extended abstract of candidate's thesis, Moscow, 2009. [Russian].
- [2] C. Sumpavakup, et al., "Optimal energy saving in DC railway system with on-board energy storage system by using peak demand cutting strategy", no. 25(4), *J. Mod. Transport*, pp. 223–235, 2017.
- [3] M. Dominguez, A. Fernandez-Cardador, A. P. Cuccala, and R. R. Pecharroman, "Energy Savings in Metropolitan Railway Substations Through Regenerative Energy Recovery and Optimal Design of ATO Speed Profiles," *IEEE Transactions on Automation Science and Engineering*, vol. 9, no. 3, pp. 496–504, Jul. 2012.
- [4] S. Yatsko, B. Sytnik, Y. Vashchenko, A. Sidorenko, B. Liubarskyi, I. Veretennikov, and M. Glebova, "Comprehensive approach to modeling dynamic processes in the system of underground rail electric traction," *Eastern-European Journal of Enterprise Technologies*, vol. 1, no. 9 (97), pp. 48–57, Jan. 2019.
- [5] D. Iannuzzi and P. Tricoli, "Optimal control strategy of onboard supercapacitor storage system for light railway vehicles," 2010 *IEEE International Symposium on Industrial Electronics*, Jul. 2010.
- [6] L. Battistelli, F. Ciccarelli, D. Lauria, and D. Proto, "Optimal design of DC electrified railway stationary storage system," 2009 International Conference on Clean Electrical Power, Jun. 2009.
- [7] S. Su, T. Tang, and Y. Wang, "Evaluation of Strategies to Reducing Traction Energy Consumption of Metro Systems Using an Optimal Train Control Simulation Model," *Energies*, vol. 9, no. 2, p. 105, Feb. 2016.
- [8] Z. Yang, Z. Yang, H. Xia, F. Lin, and F. Zhu, "Supercapacitor State Based Control and Optimization for Multiple Energy Storage Devices Considering Current Balance in Urban Rail Transit," *Energies*, vol. 10, no. 4, p. 520, Apr. 2017.
- [9] B. Sytnik, V. Bryksin, S. Yatsko, and Y. Vashchenko, "Construction of an analytical method for limiting the complexity of neural-fuzzy models with guaranteed accuracy," *Eastern-European Journal of Enterprise Technologies*, vol. 2, no. 4 (98), pp. 6–13, Mar. 2019.
- [10] S. Ruigang, Y. Tianchen, Y. Jian, and H. Hao, "Simulation of braking energy recovery for the metro vehicles based on the traction experiment system," *SIMULATION*, vol. 93, no. 12, pp. 1099–1112, Aug. 2017.

## РОЗВИТОК СТРАТЕГІЙ ЗМЕНШЕННЯ СПОЖИВАННЯ ТЯГОВОЇ ЕНЕРГІЇ ЕЛЕКТРИЧНИМ РУХОМИМ СКЛАДОМ

Сергій Яцько, Ярослав Ващенко,  
Анатолій Сидоренко

У статті розглянуто захід підвищення енерго-ефективності перебігу режиму тягового енергоспоживання під час роботи не автономного електричного рухомого складу обладнаним бортовим накопичувачем енергії. Ідея полягає у використанні бортового накопичувача енергії електричного гальмування як додаткового джерела живлення тягового електроприводу в процесі розгону транспортного засобу та в узгодженні його роботи з системою енергопостачання. Це дає змогу не тільки забезпечити незалежність процесів електроспоживання і відновлення кінетичної енергії тяговим рухомих складом, але й знизити втрати в елементах систем тягового і зовнішнього електропостачання. Для підтвердження ефективності запропонованого заходу проведено імітаційне моделювання роботи поїзду метро з асинхронним тяговим електроприводом у поєднанні із запропонованою системою. Отримані результати, у конкретному випадку, продемонстрували скорочення втрат енергії в елементах системи тягового електропостачання під час розгону електропоїзда на 45 % порівняно з втратами при використанні штатної системи тягового електроприводу. З акцентовано увагу на факторах, та їхньому характері, котрі суттєво впливають на протікання режимів тяги та електричного гальмування.



**Serhiy Yatsko** – Ph. D., associate professor, Department of Power Engineering, Electrical Engineering and Electromechanics” Ukrainian State University of Railway Transport In 1976 he graduated from Odessa Polytechnic Institute, speciality “Electric Drive and Automation of Industrial Plants”. Thesis defended before a special Academic

Council in Lugansk Machine Construction Plant by the specialty of “Railway Rolling-Stock and Train Traction”. Scientific interests: electric traction systems efficiency increase. Author of 90 scientific works.





**Yaroslav Vashchenko** – Ph. D, Senior lecturer of the Department of Power Engineering, Electrical Engineering and Electromechanics, Ukrainian State University of Railway Transport. In 2011 he graduated from Ukrainian State University of Railway Transport, the specialty Electric Transport. Thesis defended at National Technical University

“Kharkiv Polytechnic Institute” in the speciality “Electric Transport”. Scientific interests: systems of traction asynchronous electric drive rolling-stock equipment control and diagnostics. Author of 17 scientific works.



**Anatoliy Sidorenko** – Postgraduate student at the Department of Power Engineering, Electrical Engineering and Electromechanics, Ukrainian State University of Railway Transport. In 2016 he graduated from Ukrainian State University of Railway Transport, speciality “Electric Transport”. Scientific interests: energy storage systems on traction rolling stock of railways. Author of 4 scientific works.